

COMUNE DI VILLAMASSARGIA (CA)

PROGRAMMA INTEGRATO
AI SENSI DELLA L. R. 29/98
CON VALENZA DI PIANO PARTICOLAREGGIATO
Comparto Casa Fenu - S. Maria della Neve

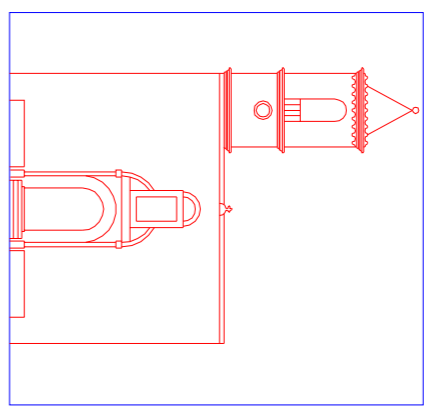







QUADRO URBANO DEGLI INTERVENTI
(stato attuale)

Il territorio attuale:
Prof. Ing. Armando Sanna
Villafraica

Il territorio comunale
Geom. Mario Perra

LEGENDA

-  Unità oggetto di int. Privato
-  Recupero primario
-  Intervento Pubblico
-  Intervento Pubblico
-  Intervento Pubblico
-  Intervento Pubblico

SCALA 1:200

